

## Impact Strength of 3D Printed Polyether-ether-ketone (PEEK)

Haijun Gong<sup>1,\*</sup>, Xiaodong Xing<sup>2</sup>, Jan Nel<sup>1</sup>

<sup>1</sup>Department of Manufacturing Engineering, Georgia Southern University, Statesboro GA, USA

<sup>2</sup>College of Mechanical and Electrical Engineering, Harbin Engineering University, Harbin, China

\*Corresponding author ([hgong@georgiasouthern.edu](mailto:hgong@georgiasouthern.edu))

### Abstract

Polyether-ether-ketone (PEEK) is a high-performance thermoplastic with high heat-, high chemical-, high water-, and high wear-resistance. Its strength and durability also make it highly accepted for a range of industrial applications. 3D printing of PEEK filaments offers a unique quality and flexibility in making PEEK parts for low-volume production or special designs. This study investigates the impact strength of 3D printed PEEK materials. The specimens are fabricated using a fused deposition modeling (FDM) based 3D printer and tested by a pendulum impact tester in compliance with ASTM standard. The testing result is discussed with respect to the processing parameters and the annealing treatment. Impact strength comparison of PEEK materials manufactured by 3D printing and by conventional production is also conducted.

### Instruction

Polyether-ether-ketone (PEEK) is a semi-crystalline polymer, which was developed in 1978. The PEEK is widely used as a high-performance thermoplastic due to its high heat-, high chemical-, high water-, high wear-resistance. Especially, PEEK and its varieties have been adopted for different biomedical treatment such as dental implants, orthopedics and maxillofacial surgery [1,2]. Its strength and durability also make it highly accepted for a range of industrial applications. For example, many automotive applications require to work at a temperature more than 120 °C. A high continuous operating temperature (260 °C) and excellent mechanical properties at this temperature make PEEK polymer the natural choice [3]. 3D printing of PEEK filaments offers a unique quality and flexibility in making PEEK parts for low-volume production or special designs. The mechanical properties of 3D printed PEEK material are of great interests to the additive manufacturing research community.

Rinaldi et al. [4] conducted mechanical, thermal (DSC), microstructural (XRD), and morphological testing of FDM printed PEEK samples. The results outlined the impact of printing parameters on the final mechanical performance and internal porosity. But there is no thermal and microstructural difference between PEEK filament and part. Want et al. [5] used finite element analysis (FEA) to simulate the melting conditions and fluidity of PEEK in a flow channel, in order to determine the parameters required to 3D print PEEK parts with sufficient surface quality and improved mechanical properties. The validation experiments suggested the heating temperature and printing speed, as well as layer thickness, to ensure a desired density and strength with minimized defect. PEEK can also be produced with carbon nanotubes (CNTs) in the FDM system to make CNT PEEK composites [6]. The influence of CNT on the mechanical performance and

microstructures was studied. The effect of thermal processing conditions on crystallinity and mechanical properties on 3D printing PEEK was studied by Yang et al. [7]. The results indicate that the temperature has a critical impact on the degree of crystallinity and mechanical properties of PEEK parts.

However, there is few researches about the impact strength evaluation of 3D printed PEEK material. The impact test measures the toughness of a material. Although the material toughness is not directly used for design purpose, it indicates the ability of the materials to withstand against impact load. The impact test is useful for understanding the resistance of the different materials or the same material in different processing conditions to impact loading. The purpose of this research is to study the impact strength of 3D printed PEEK material.

### Experimental

CreatBot F430 high-temperature 3D printer is used for fabricating the PEEK impact testing specimens. It has two hotends, one of which can be heated to 420 °C to print PEEK filament, as shown in Fig. 1. The PEEK filament (non-medical grade) came with the 3D printer, with a diameter of 1.75 mm.

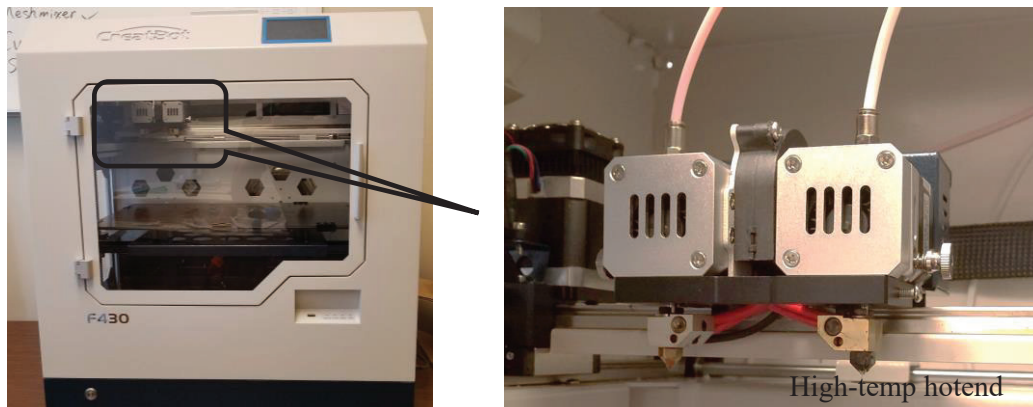

Fig. 1 High-temperature 3D printer and hotends

Impact testing specimen has a standard size for Izod pendulum impact resistance test, conforming to ASTM D256. A hammer is raised to a specific height and then released. The hammer swings down hitting a notched specimen. The energy absorbed by the specimen is measured to calculate the impact strength. The 3D printer exerts printing for a 100% fill rate to the infill region (raster scan) after double contouring scans, as illustrated in Fig. 2. The direction of infill scan is re-oriented 90° every layer to ensure a good bonding. The notch of the specimen is created directly by 3D printing, instead of being cut by a notcher. The purpose is to see if the “printed notch” similarly causes a dramatic stress concentration and crack propagation resulted from impact load. An Instron CEAST 9050 pendulum impact tester (Fig. 3) is employed to measure the Izod impact strength. PEEK is a semicrystalline thermoplastic, with a glass transition temperature of 143 °C (289 °F) and melting temperature of 343 °C (662 °F). The heating temperature needs to be elevated higher than the melting point to ensure a continuous extrusion. The melted PEEK exhibits a fast solidification rate from liquid phase to solid. Also, the scan speed must be slow for PEEK filament, as suggested by the machine vendor. The process parameters of 3D printing PEEK are listed in

Table 1. Annealing is conducted in the furnace to the impact specimens to improve the crystallinity. The annealing recipe is shown Fig. 4.

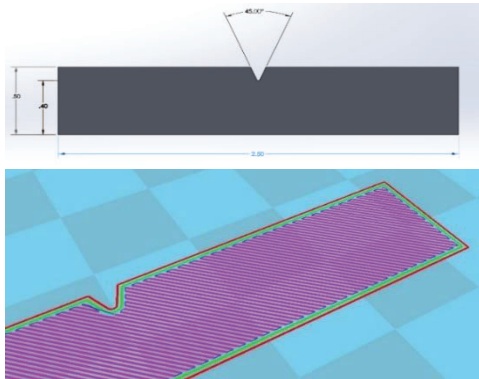

Fig. 2 Izod specimen and scan pattern



Fig. 3 Instron CEAST 9050 impact tester

Table 1. 3D printing PEEK parameters

Layer thickness (mm)	0.15
Fill density (%)	100
Scan speed (mm/s)	20
Nozzle temperature (°C)	420
Bed temperature (°C)	80

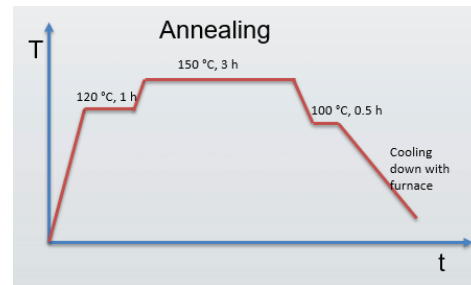

Fig. 4 Annealing temperature of 3D printed PEEK

## Results and Discussion

**Deformation and Delamination of PEEK Parts.** The 3D printed PEEK specimens exhibit apparent deformation (warping) due to the thermal strain as shown in Fig. 5(a). The warping deformation has been proved to be closely correlated to the chamber temperature and nozzle temperature [8]. The deformation results in delamination of PEEK specimen off the build plate, which might cause serious contacting with printing head. Otherwise, the as-built PEEK specimen (non-annealed) presents a weak bonding strength of between layers, as shown in Fig. 5(b). The crack can be easily developed when load is applied to the specimen for removal from the build plate. Extra caution should be used to take the specimen off the plate.

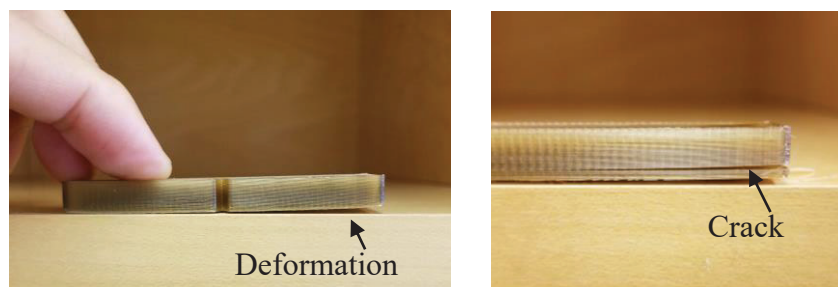

Fig. 5 Deformation and interlayer crack of 3D printed PEEK Parts

**Annealing and crystallinity.** The crystallinity levels of the as-built PEEK specimens are increased through the annealing heat treatment. After annealing, the thermal history, dimensional changes, and residual stress are removed, correspondingly resulting in an improved mechanical property. The enhanced bonding strength between layers is a strong evidence of the improvement. A comparison of impact testing to the as-built specimen and the annealed specimen also demonstrates the effect of annealing to the PEEK parts. As shown in Fig. 6, when the hammer hits the as-built PEEK specimen, the impact load does not cause a crack initiated from the notch. Instead, it causes interlayer debonding of the rear face (Fig. 6(a)). The weak bonding is not desired to the 3D printed PEEK parts, since it fails to resist the impact loading as expected. On the contrary, the annealed PEEK specimen shows an expected failure mode, which has a crack initiated from the notch. The rear face of the specimen (Fig. 6(c)) exhibits good bonding between layers after the specimen is broken.

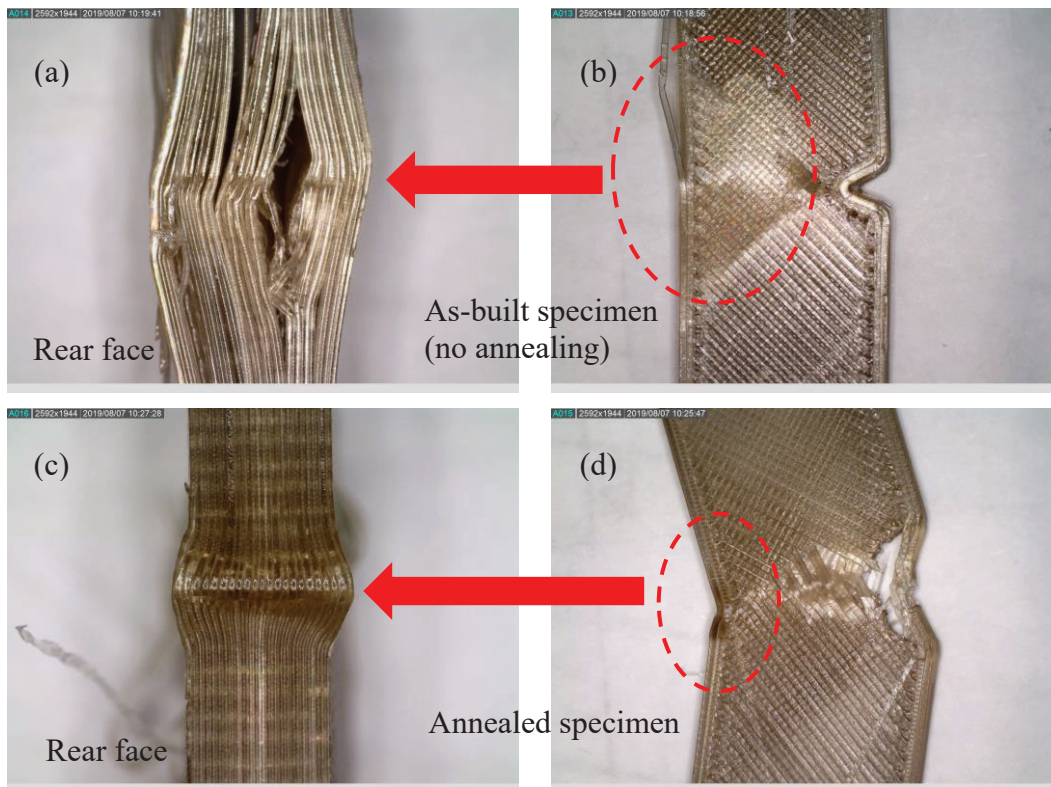

Fig. 6 Comparison of as-built and annealed specimens after impact loading

**Impact strength.** The impact strength of 3D printed PEEK specimens is shown in Fig. 7. Some reference values are included in the same diagram for comparison. It is noted that the impact strength ( $73 \pm 12 \text{ KJ/m}^2$ ) of the PEEK specimens tested in this study is much higher than other notched PEEK materials. The value is comparable to the un-notched Victrex PEEK 450G material (impact strength  $70 \text{ KJ/m}^2$ ) which is glass fiber reinforced. The high impact strength value deserves a further confirmation with more tests. Otherwise, the impact strength value also indicates the 3D printed notch does not perform the same to the notch cut by a notcher. A comparison study is necessary for the future research. In addition, the annealing recipe is believed to influence the material properties in a certain extent. The crystallization of polymer is associated with the partial alignment of its molecular chain. The impact strength of the semi-crystalline PEEK material is

determined by the crystallinity and the size/orientation of the molecular chains. Both annealing and scan strategy play an important role to the impact property of 3D printed PEEK material.

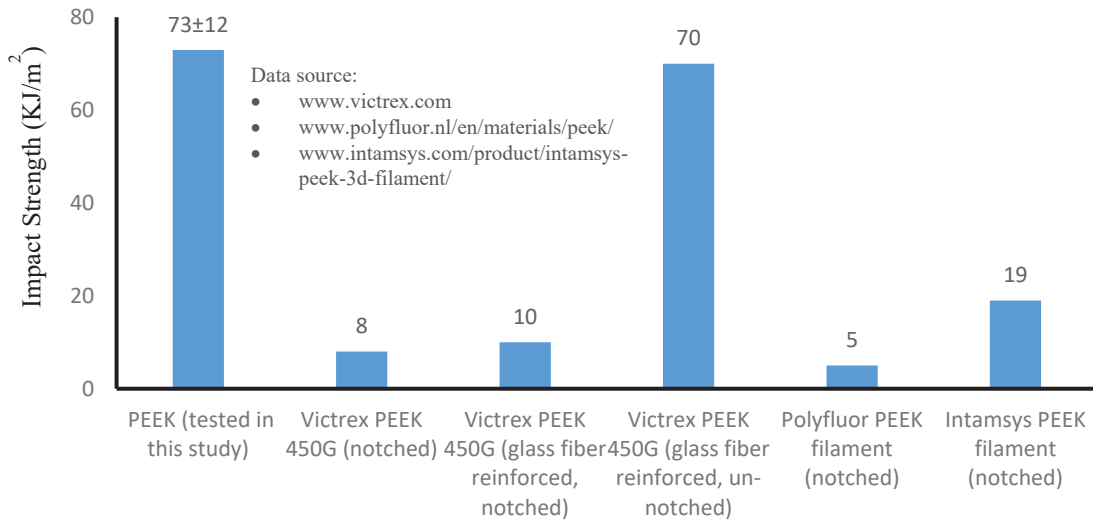

Fig. 7 Impact strength of 3D printed PEEK materials

**Fractography.** The fracture face of the PEEK specimen is shown in Fig. 8. It is noted that the fracture is primarily attributed to the tension rupture of the extruded thin strands. The bonding force between layers or between strands also contributes to the impact strength. But the accumulated tension strength of the thin strands is of great importance to the impact loading performance, due to the aligned molecular chains.

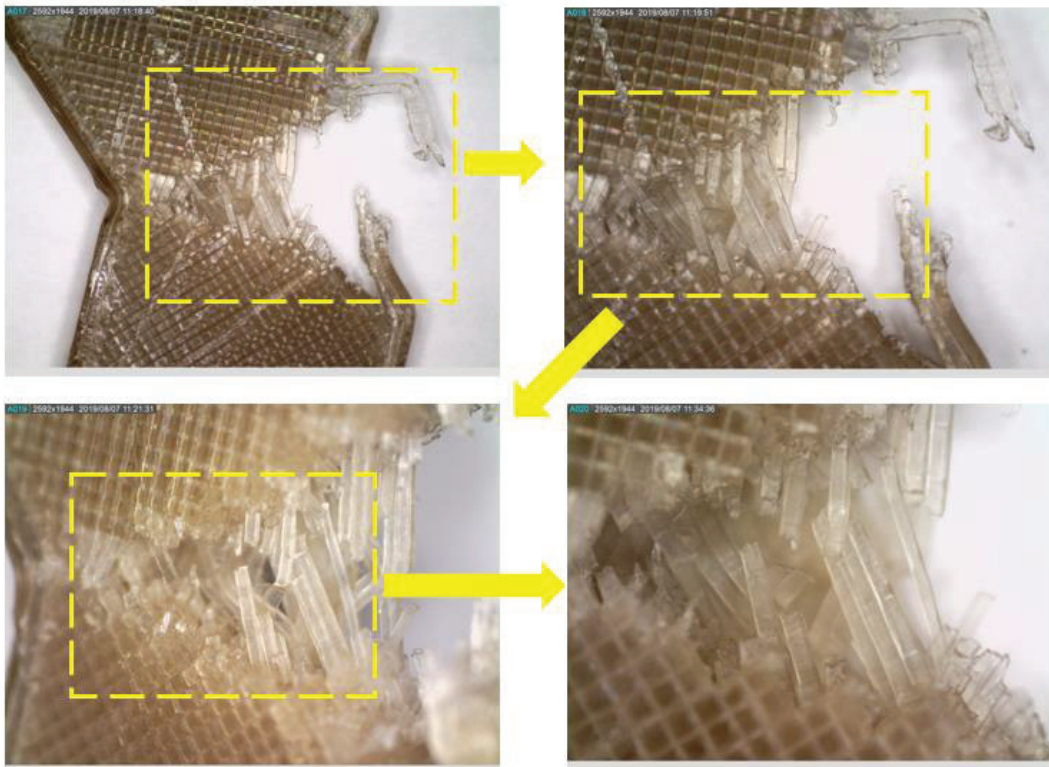

Fig. 8 Fracture face of the 3D printed PEEK impact specimen

## Conclusion

This study concentrates on the impact testing (Izod pendulum testing) of 3D printed PEEK material. It shows that the annealing process improves the levels of crystallinity of PEEK specimens, which has a high impact strength. More tests deserve to be conducted to validate the result. Also, the 3D printed notch is not the same as the cut notch. The accumulated tension strength of the extruded thin strands contributes much to the impact strength.

## Reference

- [1] S. Singh, C. Prakash, S. Ramakrishna, 3D printing of polyether-ether-ketone for biomedical applications, *European Polymer Journal*, **114** (2019) 234-248.
- [2] D. Garcia-Gonzalez, A. Rusinek, T. Jankowiak, A. Arias, Mechanical impact behavior of polyether-ether-ketone (PEEK), *Composite Structures* **124** (2015) 88-99.
- [3] [http://www.netmotion.com/htm\\_files/advisory/advisor\\_peekauto.htm](http://www.netmotion.com/htm_files/advisory/advisor_peekauto.htm)
- [4] M. Rinaldi, T. Ghidini, F. Cecchini, A. Brandao, F. Nanni, Additive layer manufacturing of poly (ether ether ketone) via FDM, *Composites Part B* **145** (2018) 162-172.
- [5] P. Wang, B.Zou, H. Xiao, S. Ding, C. Huang, Effects of printing parameters of fused deposition modeling on mechanical properties, surface quality, and microstructure of PEEK, *Journal of Materials Processing Tech.* **271** (2019) 62-74.
- [6] S. Berretta, R. Davies, Y.T. Shyng, Y. Wang, O. Ghita, Fused deposition modelling of high temperature polymers: exploring CNT PEEK composites, *Polymer Testing* **63** (2017) 251-262.
- [7] C. Yang, X. Tian, D. Li, Y. Cao, F. Zhao, C. Shi, Influence of thermal processing conditions in 3D printing on the crystallinity and mechanical properties of PEEK material, *Journal of Materials Processing Tech.* **248** (2017) 1-7.
- [8] W. Z. Wu, P. Geng, J. Zhao, Y. Zhang, D. W. Rosen, H. B. Zhang, Manufacture and thermal deformation analysis of semicrystalline polymer polyether ether ketone by 3D printing, *Materials Research Innovations*, **18 sup5** (2014), S5-12-S5-16.